

This camera manual library is for reference and historical purposes, all rights reserved.

This page is copyright by mike@butkus.org M. Butkus, N.J.

**This page may not be sold or distributed without the expressed
permission of the producer**

I have no connection with any camera company

If you find this manual useful, how about a donation of \$3 to: M. Butkus, 29 Lake Ave., High Bridge, NJ 08829-1701 and send your E-mail address too so I can thank you. Most other places would charge you \$7.50 for a electronic copy or \$18.00 for a hard to read Xerox copy. These donations allow me to continue to buy new manuals and maintain these pages. It'll make you feel better, won't it?

If you use Pay Pal, use the link below. Use the above address for a check, M.O. or cash. Use the E-mail of butkusmi@ptd.net for PayPal.



[back to my "Orphancameras" manuals /flash and light meter site](#)

Only one "donation" needed per manual, not per multiple section of a manual !

The large manuals are split only for easy download size.



Canon TX



INSTRUCTIONS

We are highly gratified that you have selected the Canon TX—a wise choice that promises you many delightful years of photographic experiences. Canon is recognized the world over as the foremost pioneer in the development of photographic equipment of the highest quality and performance. Whether your new TX is for the home or for traveling, make the most of your opportunities!

Before Using . . .

Please read this instruction booklet carefully, and master the manipulations of the various parts of the TX completely. Once thoroughly versed in the correct handling of this camera, you can use the Canon TX to the fullest extent of its capabilities.



Contents

Technical Data	8
Loading Mercury Battery	10
Film Winding	11
Shutter and Aperture Adjustment	13
Using Built-in Exposure Meter	17
Exposure Settings	19
Coupling Range of Built-in Exposure Meter	22
Viewing and Focusing	23
Holding the Camera	25
Film Loading	27
Film Rewinding	30
Synchronizing Flash Unit	31
Changing Lenses	32
Double Exposures	37
Filters	38
Interchangeable Lenses and Accessories	39
Proper Care of the Camera	43

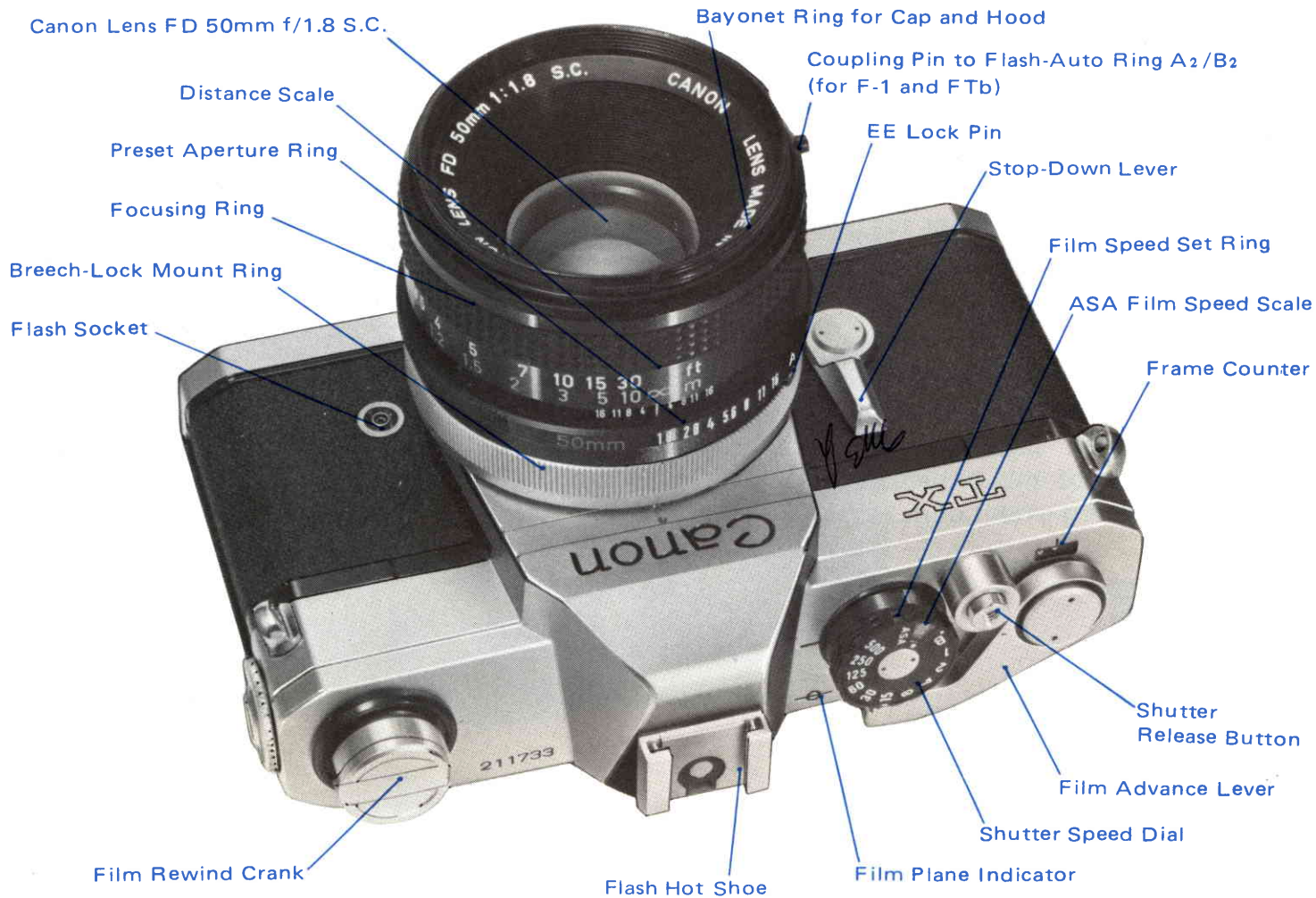

Follow these simple steps for normal photography:

- 1** Load the film. (See page 27.)
- 2** Set the ASA film speed. (See page 18.)
- 3** Wind the film advance lever. (See page 27-28.)
- 4** Remove the lens cap.

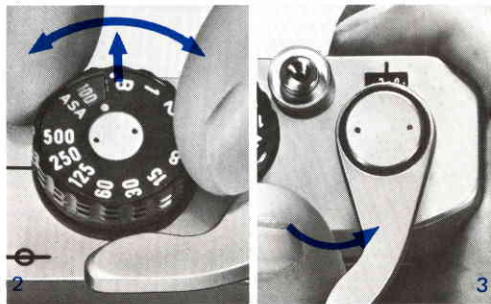
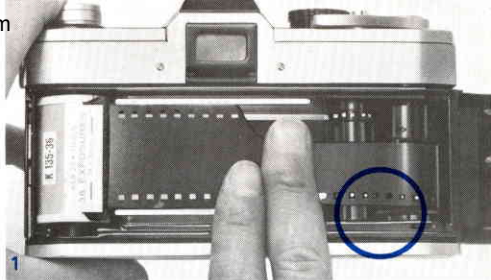



5

5 Look through the viewfinder and focus. (See page 23.)

6 Determine the exposure by adjusting the shutter speed dial and the preset aperture ring. (See page 13.)



6/7



7 Compose the picture.

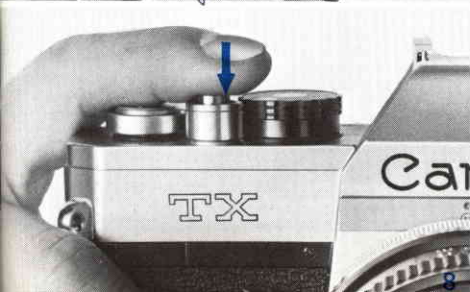

8 Press the shutter release button gently.

Technical Data

- Type: 35mm single-lens reflex camera with focal plane shutter. Picture size; 24x36mm.
- Standard Lens: Canon FD 50mm f/1.8 S.C.
- Interchangeable Lenses: Canon FD series lenses for full aperture metering and FL series lenses for stopped-down metering.
- Viewfinder: Eye-level type using pentagonal prism.
- Viewfinder Attachments: Angle Finder A2, B, Magnifier S, Rectangular Type Eyesight Correction Lenses (−1.2 diopter as Standard. Interchangeable with +3, +2, +1.5, +1, +0.5, 0, −0.5, −2, −3 and −4.)
- Focusing Screen: Microprism screen rangefinder using Fresnel lens.
- Field-of-View: 94% of actual picture area.
- Magnification: 0.85X with standard 50mm lens at infinity.
- Viewfinder Information: Meter needle and aperture needle, red signal indicating outside lower side of meter coupling range, meter index for stopped-down metering and coupling range limit marks.
- Mirror: Shockless quick return system.
- Lens Mount: Canon Breech-lock FD mount. FL and R series of lenses mountable.
- Coupling Function of Lenses: FD lenses; full aperture metering, coupled with automatic diaphragm. FL lenses; stopped-down metering, coupled with automatic diaphragm. R lenses; stopped-down metering, manually operated diaphragm.
- Shutter: Focal plane shutter with speeds from 1/500 to 1 sec. and B. Equiinterval index. X contact at "60".
- Shutter Speed Dial: With shutter speed scales and ASA film speed scales.
- Film Speed Scale: ASA 25 to 2000.
- Exposure Meter: Built in. Coupled to shutter speeds, film speeds and f/stop. Matching needle type full-aperture metering mechanism through the lens. Central emphasis average

light metering system using CdS photocell behind the pentaprism. Full aperture opening f/stop automatic compensation mechanism for the FD lenses. Stopped-down metering possible. Meter index type metering, using stopped-down lever. Powered by one 1.35V mercury battery, Mallory PX625 or Eveready EPX625.

- Exposure Meter Coupling Range: When using FD 50mm f/1.8 S.C. with ASA 100 film, EV3.7(f/1.8 at 1/4 sec.) to EV 17 (f/16 at 1/500 sec.).
- Flash Synchronization: FP and X contact. Automatic time lag adjusting. Flash contact in the flash hot shoe plus PC socket on the front of the body.
- Synchronizing Range: FP class; 1/500-1/125 sec., 1/30 sec. or under. Speedlite; 1/60 sec. or under. M, MF class; 1/30 sec. or under.
- Film Loading: By opening back cover. Accepts any standard 35mm film roll in cartridge. Easy and rapid loading with the multi-slotted film spool.
- Film Advance Lever: Single operation 174°. Short-stroke winding possible.
- Film Rewinding: Performed by rewind button and crank.
- Double Exposures: Possible by operating film rewind button and crank.
- Frame Counter: Self-resetting type activated by opening back cover.
- Size: 144 x 93 x 43mm (5-5/8" x 3-5/8" x 1-3/4").
- Weight: 680g (1 lb. 8 ozs.)—body only.

Subject to change without notice.

"Spectra Coating" and "Super Spectra Coating" are abbreviated as "S.C." and "S.S.C." respectively.

Loading Mercury Battery

The built-in exposure meter of the Canon TX functions only when the mercury battery is properly loaded.

- 1 Insert a coin into the groove of the battery compartment cover and turn it to the left to remove.
- 2 Face the central contact (\ominus) of the mercury battery inwards and insert.
- 3 Replace the cover by turning it to the right. Be sure to insert the battery in the correct direction by referring to the diagram on the compartment cover. Otherwise, the cover cannot be properly screwed in.
- 4 Before inserting, wipe off fingerprints or stains from the battery poles with a dry cloth. Otherwise, the meter may not function due to imperfect contact, and dirty poles may cause corrosion and damage the contact points of the camera.
- 5 1.35V mercury battery should be used—equivalent to Mallory PX-625, Eveready EPX-625. Life of the battery in normal use is approximately one year.
- 6 If the camera will not be used for an extended length of time, the battery should be taken out of the battery compartment to prevent possible damage to the terminals from battery corrosion.
- 7 Replace the battery every year as a precaution.



Film Winding

The film advance lever winds the film, cocks the shutter, and prepares the aperture and mirror for the next shutter release all in one motion.

1 Turn the film advance lever until it stops. The film will be advanced one frame and the shutter cocked. The frame counter is simultaneously advanced to the next number.

2 When the shutter release button is pressed, the mirror flips up, the diaphragm simultaneously closes down to the preset f/stop and the shutter operates. After the shutter is operated, the advance lever can be wound for the next frame.

- Winding may be done by moving the lever with several short strokes.
- The shutter will not function when pressing the shutter release button unless winding is completed. In such a case, check the winding once more.

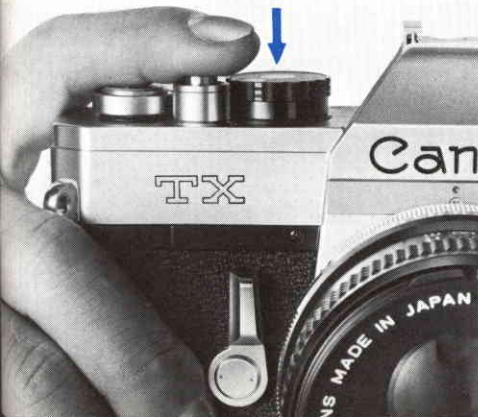
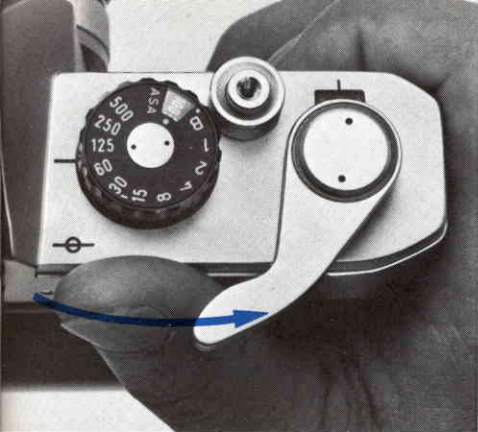

Frame Counter

Each winding will advance the number of the frame counter, indicating the number of pictures taken. When the back cover is opened, the counter automatically returns to starting position "S".

Attaching the Cable Release

The optional Canon Release can be attached to the TX by screwing it into the threaded hole in the center of the shutter release button. The use of a cable release is recommended when the camera is attached to a tripod both for time-exposure photography and tele-photography. Moreover, it is very convenient for copy work together with a tripod or copy stand.

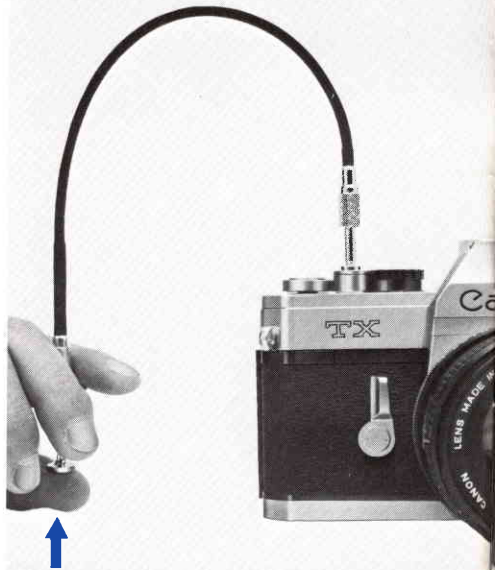
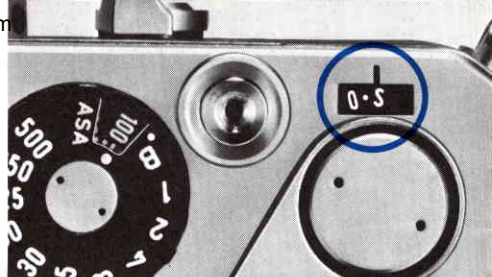

Shutter and Aperture Adjustment

Exposures are adjusted by the shutter and aperture. The shutter controls the exposure time and the aperture controls the amount of incoming light. The Canon TX uses a matching needle metering system, a very simple method of obtaining proper exposures.

Shutter Speed Dial

Adjust the shutter speed by turning the shutter speed dial to the desired index number. The index on the dial shows the denominators of 1/500 sec., 1/250 sec., etc.

- The shutter speed dial does not revolve between indexes "500" and "B".
- Be sure to set the index at a position where the clickstop catches. In case of "B" index, adjust it to the white dot just below the "B" index.
- "B" indicates bulb exposure, and is used when making exposures of more than one second. When the shutter speed dial is set at "B", the shutter remains open as long as the shutter release button is pressed.
- When it is necessary to make an exposure over an extended time, use the lockable cable release.
- The "60" index is also used for synchronizing an electronic flash unit such as a Canon Speedlite. Then it is

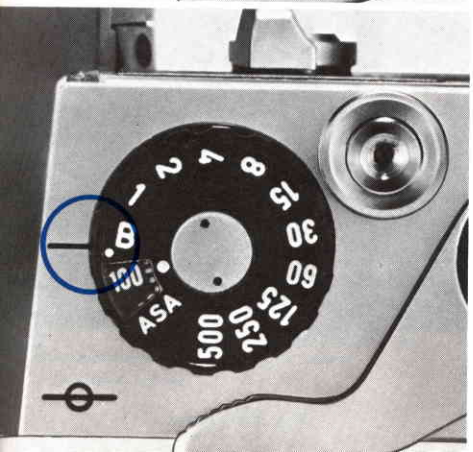
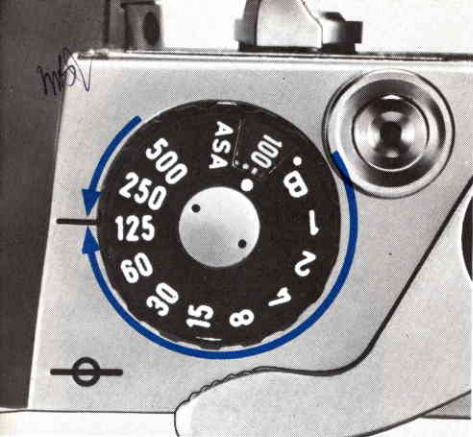

equivalent to a very short exposure time during the flash of the flash unit.

Aperture

The aperture is set by turning the preset aperture ring to the desired f/stop.

- As the f/stop number gets larger, the amount of light reaching the film plane becomes correspondingly less. For each f/stop up, the light is reduced one-half. Accordingly, when the aperture is increased by one f/stop, the exposure is doubled, and when it is increased by two f/stops the exposure is quadrupled.
- The maximum aperture of a lens may not be one included in the international standard series. If it is not, the second f/stop will not designate an aperture one-half as large as the first f/stop.
- The ratio between the aperture and the amount of exposure, using f/2 as the basis, is as follows:

f/stop:

1.2 1.4 1.8 2 2.8 3.5 4 5.6 8 11 16 22

Exposure Ratio:

3 2 1.25 1 1/2 1/3 1/4 1/8 1/16 1/32 1/64 1/128

- The preset aperture ring can also be set between two f/stops.





Automatic/Manual
Aperture Lever

FD 50mm f/1.4 S.S.C.



Automatic/Manual
Aperture Lever

Manual Aperture
Lock Lever

FD 35mm f/3.5 S.C.

Automatic Control of Aperture

In the case of the FD or FL lens, the field-of-view can always be seen through the viewfinder at full aperture opening even after the f/stop has been set with the preset aperture ring. Set the desired f/stop on the preset aperture ring to the index. The diaphragm will close down to the preset f/stop only for the instant that the shutter is released. Except for that instant, the diaphragm remains fully open.

Manual Control of Aperture

1 By pressing the stop-down lever and turning the preset aperture ring, the diaphragm can be closed down to any f/stop and the depth-of-field at the time of shutter release can be checked. When the lever is reset to its original position, the diaphragm again returns to maximum opening.

- The aperture is manually stopped down also when performing close-up photography and macrophotography.

2 In the case of the lens which has a manual aperture lock lever, turn the automatic aperture lever of the lens counterclockwise all the way and set the manual aperture lock lever at the "L" position before mounting the lens. This manual aperture lock lever locks the automatic aperture lever and the diaphragm can be opened or closed by turning the preset aperture ring. For releasing the lever, return the manual aperture lock lever to the original position at the white dot.

- The preset aperture ring cannot be set at the "A" mark when the FD lens is attached to the TX.
- Refer to page 35 concerning the depth of the field.

When an FD lens without the lock lever is used and manual control of aperture is required, turn the automatic/manual aperture lever of the lens counter-clockwise until it is automatically locked. The aperture can be opened or closed by turning the preset aperture ring. For releasing the lever, turn it clockwise.

When using the lens attached to the macrophoto coupler for macrophotography etc., set the automatic aperture lever of the lens in the position for manual operation, attach the macrohood of the macrophoto coupler to the lens mount, and turn the breech-lock mount ring.

Relationship Between the Shutter, Diaphragm, and Mirror

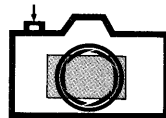

Press the shutter release button.



Mirror begins to snap up.



The shutter clicks.
The diaphragm closes down to preset f/stop.



Mirror is up.

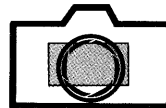

The diaphragm returns to maximum opening.



Mirror returns to former position.

Using Built-in Exposure Meter

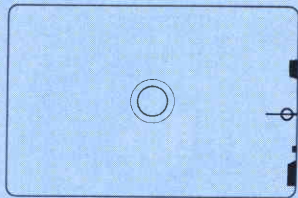
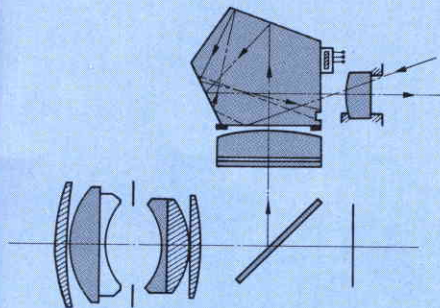

Canon TX provides the most accurate light measurement possible with its unique TTL (Through-The-Lens) system. The built-in exposure meter, which is of matching needle type, is coupled to the ASA film speed scale, shutter speed dial and preset aperture ring.

The CdS photocell of the exposure meter is located above the eyepiece at the rear of the pentagonal prism. The central emphasis light metering system enables accurate measurement of the main subject even in counterlight.

- The correction of the full aperture opening of the lens is performed automatically. Therefore, the operation does not change regardless of the speed of the lens used. An FL lens can be used only with stopped-down metering.

- Due to the characteristics of the CdS photocell, the movement of the meter needle may occasionally become slow, owing to changes in the degree of light.

- Metering at "B" on the shutter speed dial is not possible with the built-in exposure meter, because "B" is used for long exposures over one second.

- Always use a lens hood when shooting against the light.

Film Speed Setting

Set the ASA film speed scale to the speed of the film being used. Film speeds are normally shown on the film box cover and/or explanatory sheet.

Lift and turn the film speed set ring around the shutter speed dial. If the film is ASA 100, for example, make the correct setting by showing "100" in the small window.

■ The following film speeds may be used:

(32)(40)	(64)(80)	(125)(160)	(250)(320)
ASA 25 . . . 50	. . . 100	. . . 200	. . .
DIN 15 . . . 18	. . . 21	. . . 24	. . .
(16)(17)	(19)(20)	(22) (23)	(25) (26)
(500)(640)	(1000)(1250)	(2000)	
400 . . . 800	. . . 1600	. . .	
27 . . . 30	. . . 33	. . .	
(28) (29)	(31) (32)	(34)	

Figures in parentheses represent intermediate film speeds.

■ When "25" appears in the small window, this is as far as the film speed setting ring will turn to the left. The white dot at the right extremity is ASA 2000.

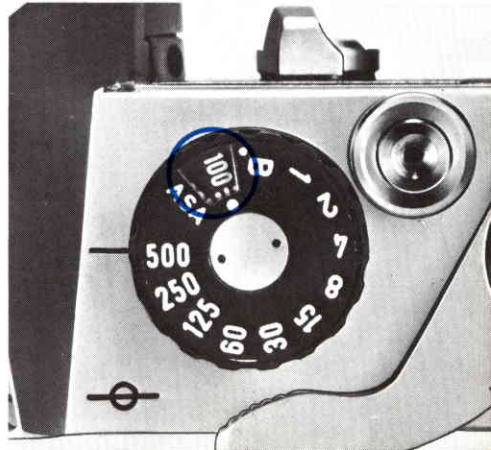
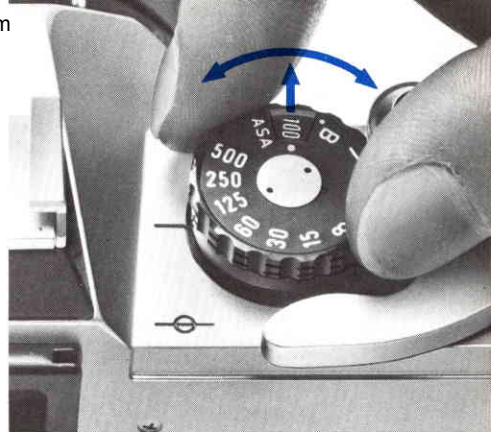

Exposure Settings

Full Aperture Metering

Full aperture metering can be performed with FD lenses.

- 1 Set the shutter speed dial at the desired speed.
- 2 Point the camera towards the subject, look into the viewfinder, and check the position of the meter needle and aperture needle.
 - The meter needle is coupled to the film and shutter speeds, and moves vertically according to the brightness of the subject. The aperture needle, with a round circle, is coupled to the preset aperture ring of the FD lens.
- 3 Turn the preset aperture ring and align the aperture needle with the meter needle.
 - The "A" mark on the preset aperture ring is for Servo EE Finder with Canon F-1 or AE cameras only.
 - In the case of f/stop priority, turn the shutter speed dial and align the meter needle with the aperture needle. Be sure to set the shutter speed dial at the click-stopped positions.
- 4 If the aperture needle does not align with the meter needle by turning the preset aperture ring, it means that the shutter speed is not properly set. In this case, align the two needles by turning the shutter speed dial.

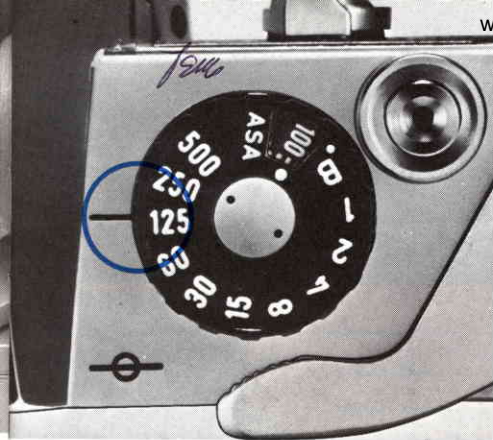

■ The moving range of the aperture needle inside the viewfinder changes according to the lens speed. And the aperture needle will not always move vertically the full length between the coupling limit marks. Then the shutter speed should be changed when the aperture needle cannot be aligned with the meter needle.

5 When the shutter is set on the high speed side, the meter needle moves downward. When it is set at a slower speed, the needle moves upward. When the shutter is set at a slow speed outside the meter coupling range, the red signal appears at the bottom of the viewfinder, and metering is not possible even if the f/stop is changed. When the red signal appears and metering cannot be performed, use a flash unit or high-speed film. Refer to "Coupling Range of Built-in Exposure Meter" on page 22.

■ Select a faster shutter speed when the meter needle swings all the way up, and a slower speed when it swings all the way down.

■ Since the shutter speed dial cannot be set at the intermediate positions, the shutter speed priority method is recommended when exposure accuracy is a crucial factor.

■ In photography under counter-light conditions, reduce film speed by one half, or open up one f/stop, after light metering.

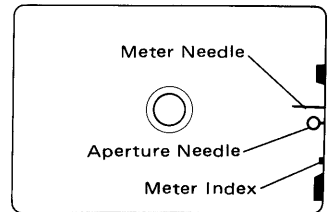

Meter Needle Moving Downward

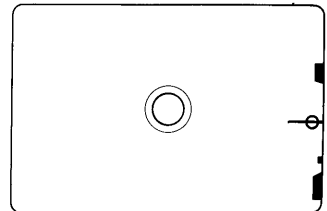

Correct Exposure

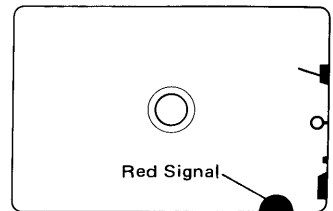

Outside the Coupling Range

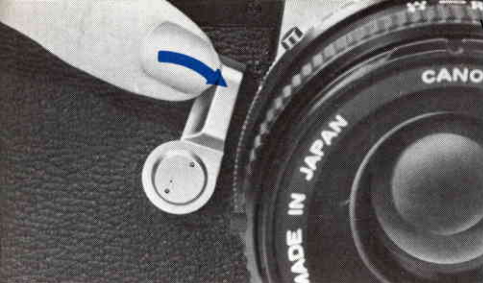

Stopped-Down Metering

When using a lens having no full aperture metering signal such as FL lenses, metering should be performed by stopping down the lens. Stopped-down metering is performed by pressing the stop-down lever.

- 1 Set the shutter speed dial at the desired speed.
- 2 Point the camera towards the subject, look into the viewfinder, and press the stop-down lever. The aperture needle will point to the lower coupling limit mark and only the meter needle remains.

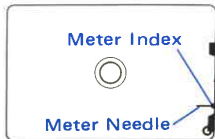
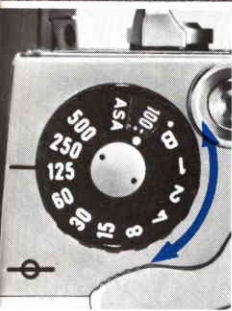

- 3 Turn the preset aperture ring and match the meter needle with the meter index in the viewfinder.

- In the case of f/stop priority, adjustments can be made with the shutter speed dial.

- 4 If the meter needle is pointing above the meter index and cannot be matched by closing the preset aperture ring and metering cannot be performed, turn the shutter speed dial to a faster speed. If the meter needle is pointing below the meter index and cannot be matched by opening the preset aperture ring, turn the shutter speed dial to a slower speed. When the red signal appears, use a flash unit or higher speed film.



Coupling Range of Built-in Exposure Meter

The built-in exposure meter couples to the following range of f/stops and shutter speeds with respective film speeds. When photographing with the film speed ASA 100, for example, the exposure meter couples within the full range from full aperture opening to f/22, between 1/4 sec. and 1/500 sec.

Film Speed		Shutter Speed									
		1	1/2	1/4	1/8	1/15	1/30	1/60	1/125	1/250	1/500
ASA	25	1	1/2	1/4	1/8	1/15	1/30	1/60	1/125	1/250	1/500
ASA	50	1/2	1/4	1/8	1/15	1/30	1/60	1/125	1/250	1/500	...
ASA	100	1/4	1/8	1/15	1/30	1/60	1/125	1/250	1/500
ASA	200	1/8	1/15	1/30	1/60	1/125	1/250	1/500
ASA	400	1/15	1/30	1/60	1/125	1/250	1/500
ASA	800	1/30	1/60	1/125	1/250	1/500
ASA	1600	1/60	1/125	1/250	1/500
Minimum f/stop		f/22	f/22	f/22	f/22	f/22	f/22	f/22	f/22	f/22	f/16

Viewing and Focusing

Composition

The exact image to be photographed can be seen on the focusing screen of the viewfinder without any parallax. This enables you to determine the exact composition of your scene before pressing the shutter release button.

Focusing

The center circular section of the viewfinder is a micro-prism screen rangefinder made up of microscopic prisms for fast and precise focusing.

While looking through the viewfinder, revolve the focusing ring. It is in focus when the image in the rangefinder becomes sharp and clear.

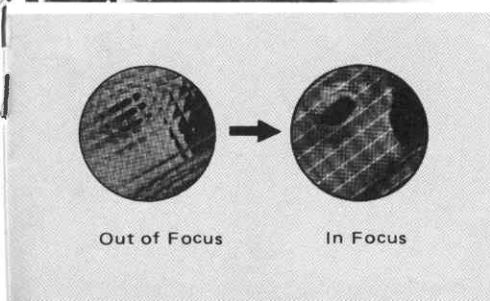

Eyesight Correction Lenses (Rectangular Type)

Eyesight correction lenses are available as optional attachments. When an eyesight correction lens is attached to the viewfinder eyepiece, those who are far- or near-sighted can take pictures without glasses. Ten different diopters of +3, +2, +1.5, +1, +0.5, 0, -0.5, -2, -3 and -4 are available. The number indicates the total diopter of the viewfinder system (-1.2) and the adjustment lens.

Angle Finders A2 and B

Canon Angle Finders A2 and B can be attached to the eyepiece for copying, close-up photography, macro-photography and photomicrography. You will see the right and left sides of the image in reverse with the Angle Finder A2, and correct with the Angle Finder B.

Magnifier S

The Canon Magnifier S can be attached to the viewfinder eyepiece of the TX, with the separately available adapter which magnifies the rangefinder section for accurate focusing. Because it can be flipped up and clamped, the entire field-of-view can easily be viewed after focusing, which is very useful for copying in great quantities.

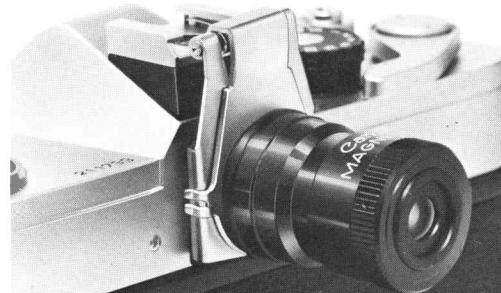
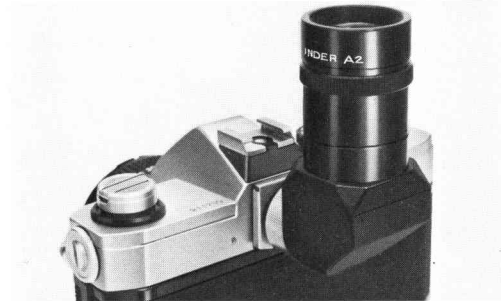
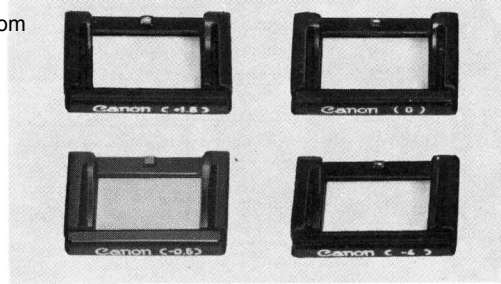

Holding the Camera

Hold the camera firmly in order to take a clear picture. Hold the camera either in a vertical or horizontal position, look through the viewfinder, and focus. Then press the shutter release button gently. The following steps are important.

- 1** Hold the camera snugly in both hands. The camera should be pressed firmly to your cheek or forehead.
- 2** When the camera is in a horizontal position, both elbows should be firmly pressed against the body, and when in a vertical position, one elbow at least should be resting against the body.
- 3** Hold your breath and press the shutter release button with a smooth, steady stroke. Otherwise, you will have a blurred picture.
 - When using a telephoto lens and/or slow shutter speeds below 1/30 sec., the use of a tripod and cable release is recommended.
 - When taking pictures against the light, always use a lens hood.
 - Camera Holder F3, for attaching a tripod, and the Canon Release are optional accessories.



Film Rewinding Crank

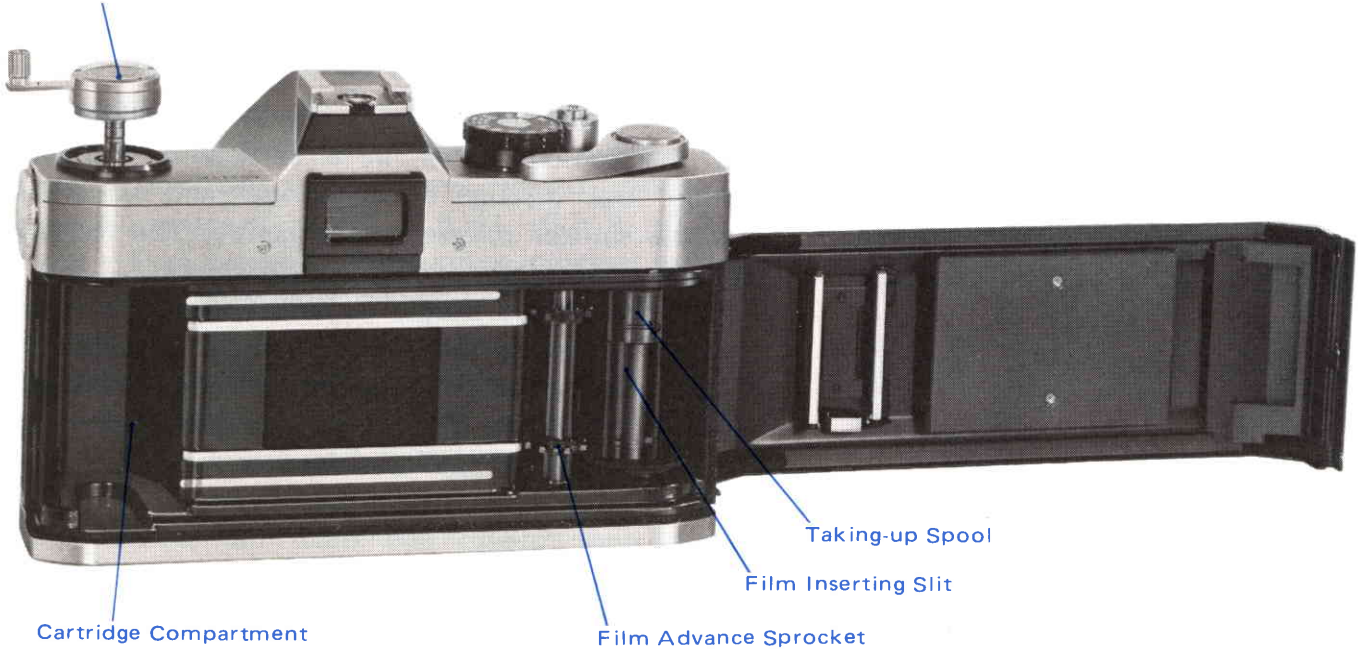

Cartridge Compartment

Taking-up Spool

Film Inserting Slit

Film Advance Sprocket

Direction in which film is placed
(emulsified surface facing the back of the lens)

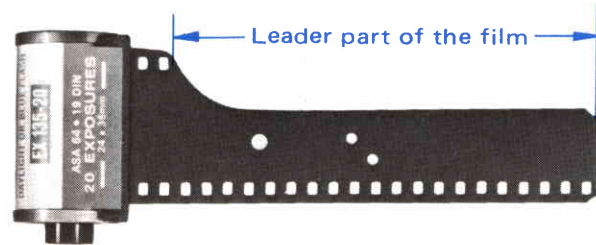

Film Loading

Canon TX accepts any standard 35mm film roll in daylight loading cartridges. Always avoid loading film in direct sunlight.

- 1 Raise the film rewind crank and pull it all the way up. The cover will open slightly.
- 2 Open the cover fully. Face the film cartridge as illustrated, and insert it into the cartridge compartment. Push the film rewind crank back into its former position. The crank fork will slip into the axis of the film cartridge. In case the crank does not fully return, turn it slightly to the left or right.

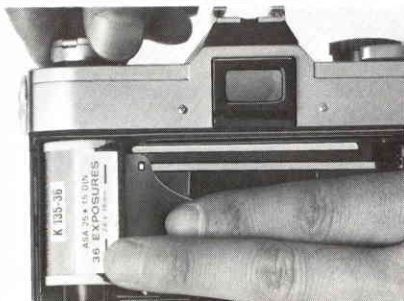
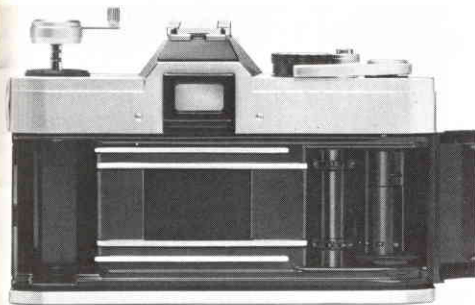
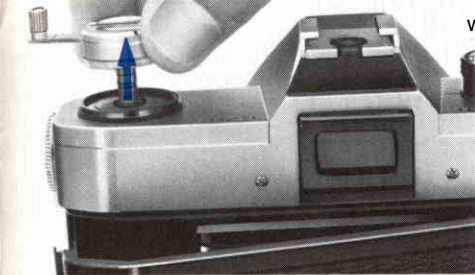

3 Pull out the film from the cartridge and insert the film tip into the slit of the film taking-up spool for a length of approximately two perforations.

4 Turn the film advance lever and wind the film around the film take-up spool to take up any excess leader. If there is excess leader, the edge of the cartridge will rise and the back cover cannot be closed.

■ At this time, engage the teeth of the film taking-up spool and that of the film advance sprocket with the film perforations.

5 Press down on the back cover and close it.

6 Leave the lens cap on and make two blank shots, each time turning the film advance lever.

The frame counter will advance from the "S" mark to "0". With one more shot and advance, the camera will be ready for the first shot.

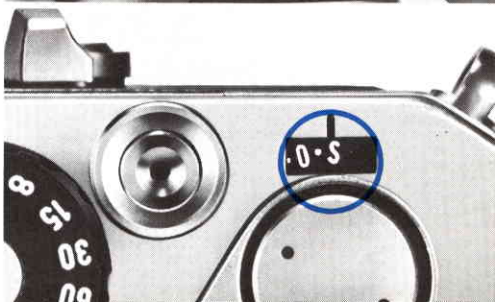
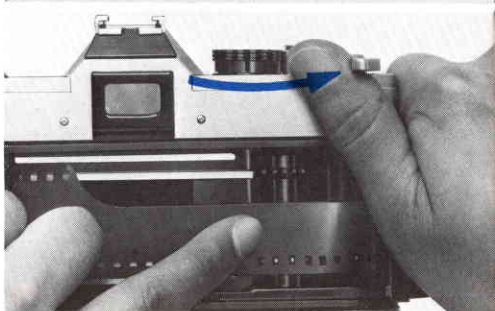
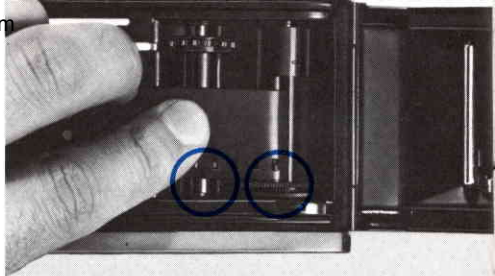



Checking Correct Film Loading

The film is properly loaded and advanced if the film rewind crank rotates counterclockwise when you wind the film advance lever. If the film rewind crank does not rotate, take out the film, as explained on the following page, and reload.

Setting the Film Speed

When loading the film, be sure to set the film speed scale at the proper position. Refer to page 18.

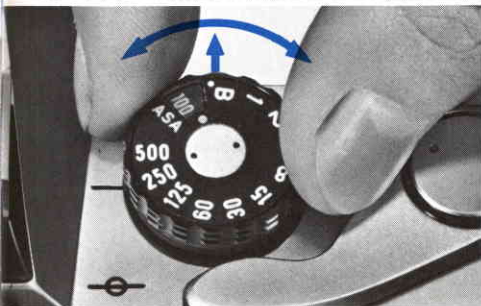

Repacking a Long Film

When loading bulk film into an ordinary cartridge, be sure to trim the tip of the leader between perforations.

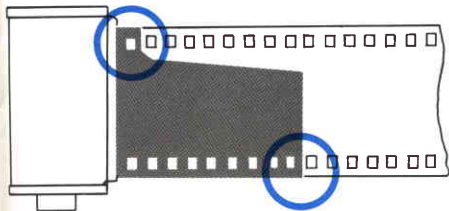

Film Rewinding

Be sure not to open the back cover before rewinding. Otherwise, the entire roll will be exposed and ruined as the exposed film is naked within the camera.

- 1 Press in the film rewind button.
 - 2 Raise the film rewind crank, turn it in the direction of the arrow, and rewind the film into the cartridge. When the film rewind button stops revolving and rewinding resistance becomes light, stop rewinding immediately in order to keep the leader part of the film outside the cartridge.
 - 3 Open the back cover.
 - 4 Pull up the rewind knob fully and remove the cartridge.
- Once the film rewind button has been pressed, the finger may be removed. The button will pop out automatically when the film advance lever is wound.
 - If you force the film advance lever after the film reaches its end, the film will become detached from the cartridge spool or tear, and rewinding will become impossible. In this case, open the back cover in a darkroom, remove the film, and put it in a light-tight box.

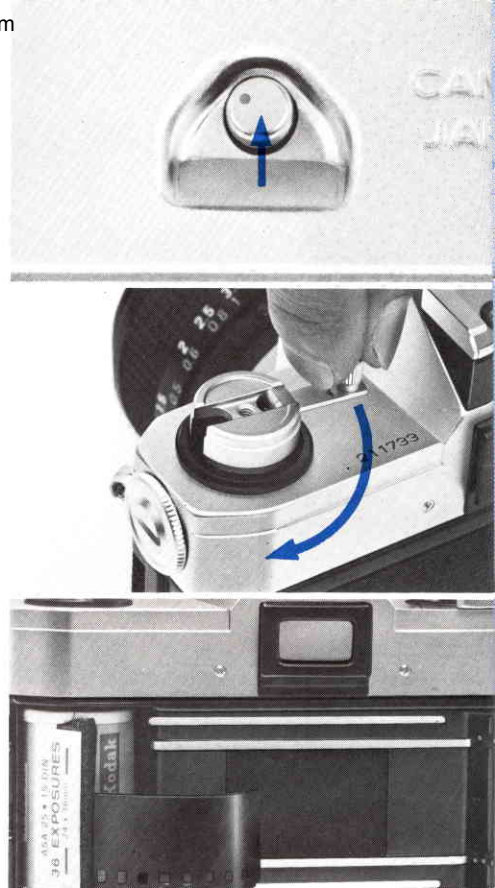

Synchronizing Flash Unit

When using an electronic flash unit or flash bulb unit, attach it to the flash hot shoe of the camera.

If the flash unit does not have flash contacts in the mounting foot, connect the cord of the unit to the flash socket of the camera.

The exposure is decided by dividing the guide number of the unit with the focusing distance and obtaining the proper f/stop.

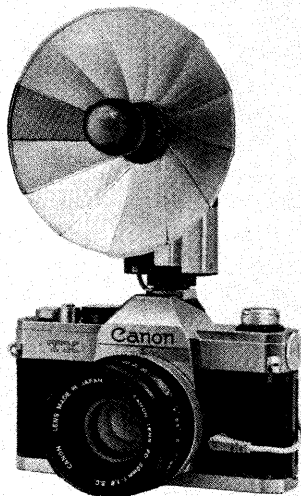

Type		Synchronized Shutter Speed
Flash bulbs	FP class (#6, Press 26)	1/125 or faster 1/30 or slower
	M class (M3, #5, Press 25)	1/30 or slower
	MF class AG-1, AG-3, M2, Flashcube	1/30 or slower
Electronic Flash Unit		1/60 or slower

- The X synchronization speed of Canon TX is 1/60 sec.
- When the cord of the flash unit is connected to the flash socket and the flash is not mounted in the flash hot shoe, attach the flash hot shoe cover to prevent electric shock.

Changing Lenses

1 Remove the lens from the camera body by turning the breech-lock mount ring of the lens to the left until the red dot on the lens coincides with the red dot on the camera mount.

2 To confirm the operation or for reverse-lens shooting, first remove the lens from the camera body. Then, press the lock pin which is located just above the positioning pin of the breech-lock mount ring with a pointed object and turn the breech-lock mount ring.

3 Mount the lens by matching the red dot of the lens to the red dot on the camera mount. Turn the breech-lock mount ring to the right and fasten.

- Attach the lens quickly in the shade. The film will sometimes become foggy if the lens is left unattached.
- To remove the dust cap of the lens, turn the breech-lock mount ring fully to the right. In this case, mount the lens onto the camera body as is.
- Whenever a lens is removed, be sure to put on the dust cap to protect the various signal levers and pins.
- To prevent a dirty or damaged mirror, do not leave the camera body without a lens for a long time.



Lens Signal

Aperture Signal Lever: Transmits the preset f/stop of the automatic aperture to the camera body.

Full Aperture Signal Pin: Transmits the full aperture f/stop when a lens with a different full aperture number is mounted. It also performs error compensation of the full aperture metering.

Automatic Aperture Lever: Stops down the aperture to the preset position. (See page 15.)

EE Lock Pin: This is a protective pin to prevent the aperture of the lens from moving to the "A" mark unintentionally. In order to set at the "A" mark, turn the aperture ring while pushing down the EE lock pin. When withdrawing from the "A" mark, turn the aperture ring again pushing down the EE lock pin.

EE Switch Pin: When the preset aperture ring is set at the "A" mark for AE use, the lens can be attached only to the Canon F-1 and AE cameras. If the lens is attached to the TX, it cannot be set at the "A" mark.

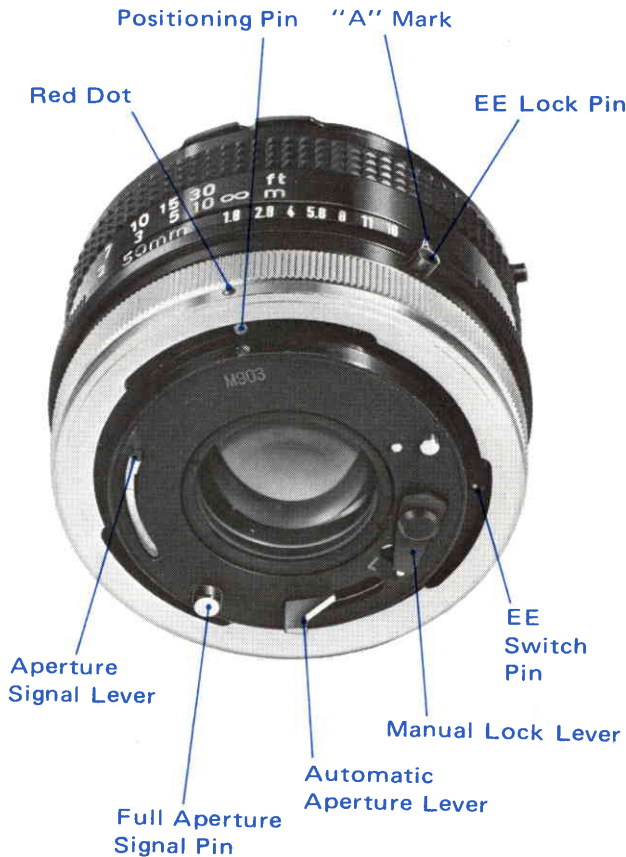

Distance Scale

www.orphancameras.com

Indicates the distance between the focused subject and the film plane. It is necessary for checking the depth-of-field, for flash and infrared photography.

- The correct position of the scale is in the center of each value. For example, the correct position of a two-digit value is the center of the two figures.

Infrared Index

For infrared photography, correction of the distance scale is necessary because the focal point slightly deviates from ordinary photography. Focus first in the ordinary manner, then adjust the distance scale to the infrared mark “.” (“R” in the case of FL lenses) in red. For instance, if the distance scale reads 10m after focusing, shift the 10 scale to “.”. The position of infrared mark on the TX is based on using film with the maximum sensitivity at 800nm, such as Kodak 1R 135 film and Wratten 87 filter.

Film Plane Indicator

When focusing is done by actual measurement, measure the distance from the film plane indicator and set the distance scale to the measured distance.

When performing close-ups, macrophotography or copy work, decide the distance of the camera from the subject with this indicator.

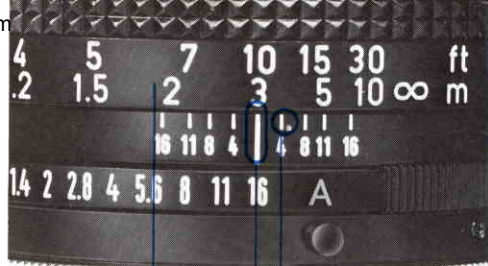

Distance Scale

Infrared Index
(red dot)

Index (orange line)

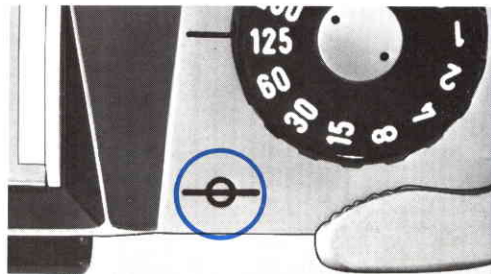

Depth-of-Field Scale

The depth of the field scale indicates the distances from the camera in which the photograph's subjects will be in sharp focus on the film. For example, if the lens used is 50mm and the subject has been focused at a distance of 3m (10'), with an f/8 value, read off from the scale on either side of the indicator (orange line). The depth-of-field is from approximately 2.3m (8') to 4.3m (14'). If the aperture is closed down to f/16, the picture will become sharp between 1.9m (6') to 7.6m (25') from the camera. Basically, the smaller the f/stop, the greater the distance of the subject from the camera or the shorter the lens focal length, the deeper will be the depth of the field. On the other hand, the larger the f/stop, the nearer the subject to the camera or the longer the lens focal length, the shallower will be the depth of the field.

■ In the case of Canon FD lenses, you can see the actual sharpness through the viewfinder by pressing the stopped-down lever.

50mm Lens f/8

Depth-of-field 2.3-4.3m (8'-14')

Focused at 3m (10')

50mm Lens f/16

Depth-of-field 1.9m-7.6m (6'-25')

Focused at 3m (10')



Lens Hood

When attaching the lens hood on the lens, align it to the bayonet ring on the lens and turn it clockwise.

With a few exceptions a lens hood can be stored in the camera case. When doing this, attach the reversed lens hood onto the lens and align it to the bayonet ring and turn counterclockwise.

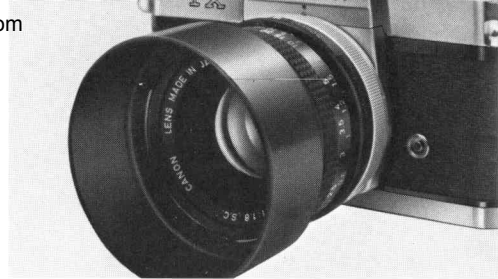

Double Exposures

Although the Canon TX is designed to prevent double exposures being made by mistake, double exposures can be made by the following steps:

- 1** When the first exposure has been made, depress the film rewind button.
- 2** Rewind the film with the film rewind crank while watching the red mark on the film rewind button carefully.
- 3** Stop rewinding when the mark has made a $7/8$ turn, i.e., 315° .
- 4** Next, wind the film advance lever while lightly holding the rewinding crank. When resistance is felt on the film rewind crank, stop winding.
- 5** Wind the film advance lever once more. The camera is ready for double exposures.
 - By repeating the above process, any number of exposures on the same frame can be made. However the frame counter will continue to advance with each exposure.

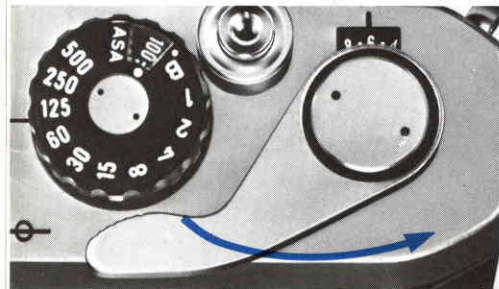
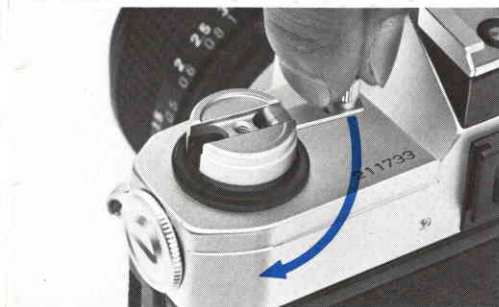

Filters

Type	Effectiveness of Filters
● UV	Absorbs only ultra-violet rays. Especially effective at seaside, and on high mountains. Recommended for use in color photography.
○ Y1 ○ Y3	Increases contrast of black and white film. Enhances clouds, darkens the blue sky. Brightens red and yellow.
○ 01	Darkens blue, increases yellow and red perceptibly. Good for contrasts especially in distant landscapes.
○ R1	Makes strong contrasts. May also be used with infrared film.
○ G1	Prevents red from turning radically into white. Lightens sky and face appropriately, and reflects the lightness of fresh greenery.
● ND4 ● ND8	ND4 reduces light values by 1/4, ND8 by 1/8. No effect on the reproduction of colors.
● SKYLIGHT	Acts to harmonize the blue sky and shade.
● CCA4	For use with daylight type film under cloudy conditions.
● CCA8	For use with tungsten type film in the morning sun or sunset.
● CCA(12)	For use with tungsten type film under sunlight.
● CCB4	For use with daylight type film in the morning sun or sunset.
● CCB8	For use with daylight type film and clear flash bulb.
● CCB(12)	For use with daylight type film under tungsten light.

○ For black and white film. ● For color film.

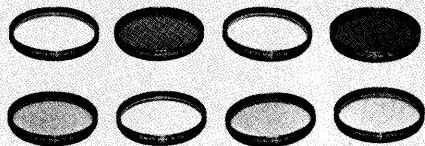

Various types of filters, according to lens thread diameters, are available for special effects in both color and monochrome photographs. The through-the-lens exposure measurement system of Canon TX does not require exposure factor compensation.

Interchangeable Lenses and Accessories

A wide range of interchangeable lenses from 7.5mm to 1200mm and various accessories are available to further enhance your Canon TX. To produce pictures of the highest quality, always use Canon interchangeable lenses with your SLR cameras.

Canon Interchangeable Lenses

- 
1. Fish-eye 7.5mm f/5.6 S.S.C.
 2. Fish-eye FD 15mm f/2.8 S.S.C.
 3. FD 17mm f/4 S.S.C.
 4. FD 20mm f/2.8 S.S.C.
 5. FD 24mm f/1.4 S.S.C. ASPHERICAL
 6. FD 24mm f/2.8 S.S.C.
 7. FD 28mm f/2 S.S.C.
 8. FD 28mm f/2.8 S.C.
 9. FD 35mm f/2 S.S.C.
 10. TS 35mm f/2.8 S.S.C.
 11. FD 35mm f/3.5 S.C. ASPHERICAL
 12. FD 50mm f/1.4 S.S.C.
 13. FD 50mm f/1.8 S.C.
 14. FD 50mm f/3.5 S.S.C. (Macro)
 15. FD 55mm f/1.2 S.S.C. ASPHERICAL
 16. FD 55mm f/1.2 S.S.C. ASPHERICAL
 17. FD 85mm f/1.2 S.S.C. ASPHERICAL
 18. FD 85mm f/1.8 S.S.C.
 19. FD 100mm f/2.8 S.S.C.
 20. FD 100mm f/4 S.C. (Macro)
 21. FD 135mm f/2.5 S.C.
 22. FD 135mm f/3.5 S.C.
 23. FD 200mm f/2.8 S.S.C.
 24. FD 200mm f/4 S.S.C.
 25. FD 300mm f/2.8 S.S.C. FLUORITE
 26. FD 300mm f/5.6 S.S.C.
 27. FD 400mm f/4.5 S.S.C.
 28. FD 600mm f/4.5 S.S.C.
 29. FD 800mm f/5.6 S.S.C.
 30. FD 24-35mm f/3.5 S.S.C. ASPHERICAL
 31. FD 28-50mm f/3.5 S.S.C.
 32. FD 35-70mm f/2.8-3.5 S.S.C.
 33. FD 80-200mm f/4 S.S.C.
 34. FD 100-200mm f/5.6 S.C.
 35. FD 85-300mm f/4.5 S.S.C.
 36. FL 300mm f/5.6 FLUORITE
 37. FL 500mm f/5.6 FLUORITE
 38. FL 400mm f/5.6
 39. FL 600mm f/5.6
 40. FL 800mm f/8
 41. FL 1200mm f/11 S.S.C.

Accessories

1. Angle Finder A2 and B
2. Eyecup 4S
3. Magnifier S
4. Camera Holder F3
5. Macrophoto Coupler FL55 and FL58
6. Lens Hood BS-55
7. Microphoto Hood
8. Photomic Unit F
9. Slide Duplicator
10. Handy Stand F
11. Gadget Bag 4-type
12. Gadget Bag G-1
13. Canon Release 30
14. Canon Release 50
15. 55mm filters
58mm filters
16. 58mm Close-up Lenses (240, 450)
17. 55mm Close-up Lenses (240, 450)
18. Macrophoto Lens 20mm f/3.5
19. Macrophoto Lens 35mm f/2.8

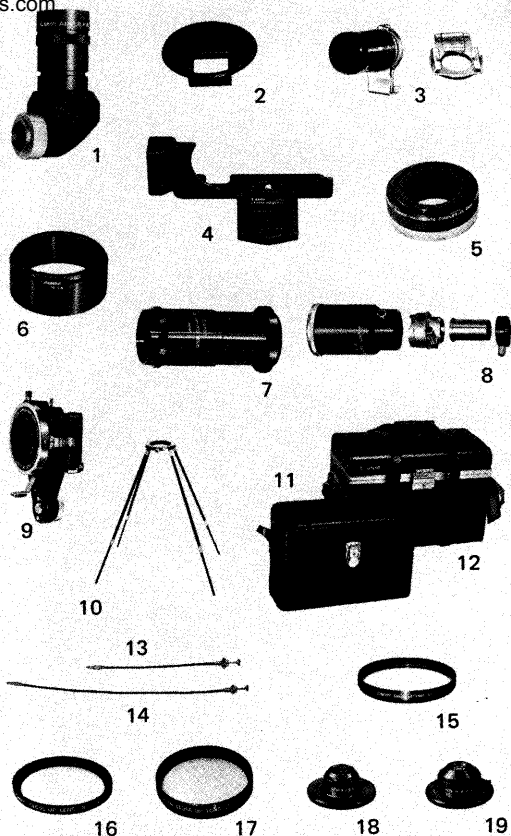

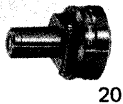

20



21



22



23



24



25

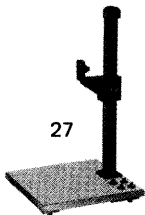

27

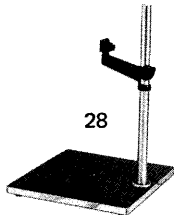

28



26



29

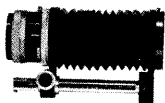

30

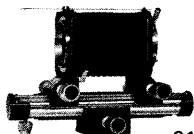

31



32



33



34

- 20. Duplicator 8
- 21. Duplicator 16
- 22. Duplicator 35
- 23. Focusing Rail
- 24. Macro Stage
- 25. Roll Film Stage
- 26. Double Cable Release
- 27. Copy Stand 5
- 28. Copy Stand 4
- 29. Auto Bellows
- 30. Bellows M
- 31. Bellows FL
- 32. Extension Tube M Set
- 33. Dioptric Adjustment Lenses (10 kinds)
- 34. Holder for Gelatin Filter with Filter Holder Adapter and Hoods

Stop-Down Lever

Aperture Signal Coupling Lever

Stopped-Down Coupling Lever

Lens Speed Adjustment Pin

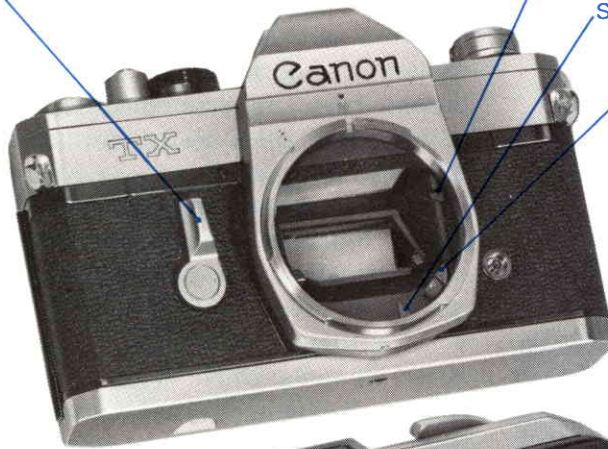

Battery Compartment

Back Cover

Film Rewind Button

Viewfinder Eyepiece

Attachment Groove
Dioptric Adjustment

Tripod Socket

